



## IEC Data Feeds

Technical documentation  
[www.iec.ch/iecdatafeeds](http://www.iec.ch/iecdatafeeds)

For further information please use the feedback on [www.iec.ch](http://www.iec.ch) or [tiss@iec.ch](mailto:tiss@iec.ch)

## Table of Contents

1	XML Publications / Corrigenda.....	4
2	XML Projects .....	8
3.	XML Working Documents (Newdocs & Revisable CDVs) .....	11
4.	XML IEC Technical Committees .....	14
5.	XML IEC Working Groups.....	15
6.	XML IEC Price Codes .....	17
7.	XML International Classification for Standards (ICS Codes) .....	17
8.	FTP.....	18
9.	Reports.....	19

## History

Version	Date	Author	Object
0.0.1	2011-10-31	IT (Mathieu Massa)	Document Creation
0.0.2	2011-11-15	IT (Mathieu Massa)	Document Update
0.0.3	2011-12-12	IT (Mathieu Massa)	Document Update (FTP)
0.0.4	2012-03-21	IT (Mathieu Massa)	Document Update (Report)
0.0.5	2012-10-16	IT (Mathieu Massa)	XML IEC Working Documents
0.0.6	2012-12-03	IT (Mathieu Massa)	XML IEC Revisable CDVs
0.0.7	2013-09-03	IT (Mathieu Massa)	Improvements XML Publications/Corrigenda
0.0.8	2014-06-13	IT (Mathieu Massa)	IEC New naming convention for Publication and Corrigenda
0.0.9	2014-06-30	IT (Mathieu Massa)	Links in NewDocs on IEC Projects
0.0.10	2015-03-11	IT (Mathieu Massa)	Add all types of publications

## 1 XML Publications / Corrigenda

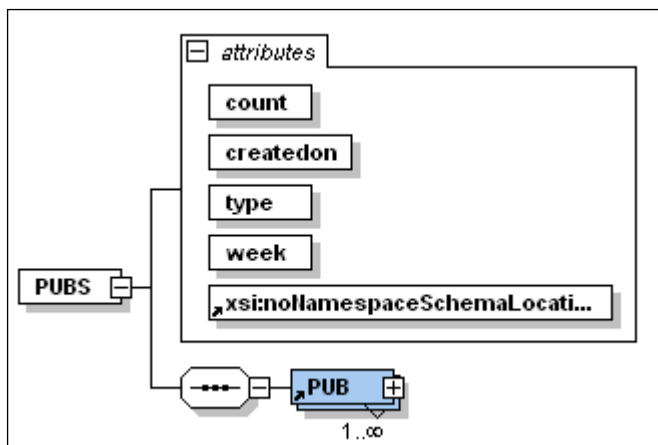

The XML format is the same for the current and replace/withdrawn publications.

The XML format is the same for the current and replace/withdrawn corrigenda (except for CORR and ISH TAG).

```
<?xml version = "1.0" encoding = "UTF-8"?>
<PUBS xmlns:xsi="http://www.w3.org/2001/XMLSchema-instance"
xsi:noNamespaceSchemaLocation="http://www.iec.ch/xsd/schemapublications.xsd" type="pubsweekly42" count=" 7227 " createdon
="2011-10-22 10:45:02">
```

- The XML format is **UTF 8**.
- Every line is indicated by XML TAG **PUB**.
- Date format is YYYY-MM-DD or YYYY-MM-DD hh:mm:ss (ex: 2004-04-05 00:00:00 or 2011-10-10)

xsi:noNamespaceSchemaLocation : URL Link to the XML Schema

type : pubs for global XML current publication

rwpubs for global XML replaced/withdrawn publication

pubsweeklyXX for weekly XML current publication, XX is the week number of current year

rwpubsweeklyXX for weekly XML replaced/withdrawn publication, XX is the current year week number

corrigenda for global XML current corrigenda

rwcorrigenda for global XML replaced/withdrawn corrigenda

corrigendaweeklyXX for weekly XML current corrigenda, XX is the week number of current year



rwcorrigendaweeklyXX for weekly XML replaced/withdrawn corrigenda, XX is the current year week

number

count : Number of publications in the XML (Number of tag PUB)

createdon : Date when the XML has been generated

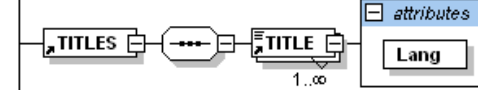
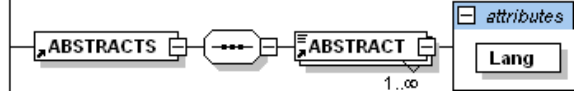
<PUB>	Tag for one publication
<ID>45696</ID>	Publication primary key (i.e. electronic ID)
<REFERENCE>IEC 60050-617:2009/AMD1:2011</REFERENCE>	Publication reference following the IEC naming convention described in <b>AC/4/2014</b>
<REFERENCE_OLD> IEC 60050-617 am1</REFERENCE_OLD>	Previous Publication reference is a concatenation of tags HEAD, TR, NUMBER, PART, SECTION, AMD
<SEQUENCE>A0060050000617000000000001A</SEQUENCE>	Tag used for publication sort
<HEAD>IEC</HEAD>	Publication header
<NUMBER>60050</NUMBER>	Publication number (mandatory)
<PART>617</PART>	Part number (optional)
<SECTION></SECTION>	Section number (optional)
<TR></TR>	Type of publication if other than International Standard. IS International Standard TS Technical Specifications PAS Publicly Available Specifications TR Technical Report TTA Technology Trend Assessment MISC Miscellaneous GUIDE Guide TRF Test Report Form
<AMD>1</AMD>	Amendment number
<CORR>1</CORR>	Not empty if the current element is a corrigenda
<ISH>1</ISH>	Not empty if the current element is an Interpretation Sheet
<EDITION>1.0</EDITION>	Full edition number of the publication. Digits before dot are for

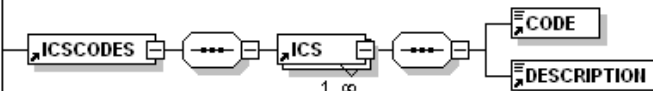
	edition number, digits after dot and not equal to 0 are for consolidated versions (1.2 stands for e first edition consolidated with its two amendments)
<CIRCULATIONDATE>2011-10-18</CIRCULATIONDATE>	Circulation Date (Publication date) of release
<LANGUAGE>EN-FR</LANGUAGE>	Publication language. EN-FR = bilingual English and French, EN = English only, FR = French only, EN-FR-RU = trilingual (English, French, Russian), EN_D = English only derived from original bilingual version, FR_D = French only derived from original bilingual version
<PROJECTS> <PROJECT> <ID>18302</ID> <REFERENCE>IEC 60050-617 am1 Ed. 1.0</REFERENCE> </PROJECT> </PROJECTS>	Projects list linked to the current publication ID : project primary key (i.e. electronic ID) which is referenced in the Project XML Data Feed REFERENCE : Project Reference 
<FILENAME>iec60050-617-amd1{ed1.0}b.pdf</FILENAME>	Publication file name
<FILEMODIFICATIONDATE>2007-07-26 08:42:45</FILEMODIFICATIONDATE>	Date and time of the document file last modification
<URLWEBSTORE>http://webstore.iec.ch/webstore/webstore.nsf/artnum/048488!opendocument</URLWEBSTORE>	Direct URL to access publication in IEC Webstore
<URLLIBRARYSERVER>http://library.iec.ch/iec-lib/libweb2.nsf/ArtNum/48488?opendocument&login</URLLIBRARYSERVER>	Direct URL to access publication in IEC Library Server
<URL>ftp://standard.iec.ch/iec60050-617-amd1{ed1.0}b.pdf</URL>	Link to access publication file through FTP
<STATUS>PUBLISHED</STATUS>	Publication Status. Can be Published, Revised, Withdrawn, or Replaced Published : Publication currently published Revised : Publication with a new version published (example v1 -> v2) Replaced : Publication replaced by other publications Withdrawn : Publication withdrawn
<MRD>2014-12-31</MRD>	Stability date (ex Maintenance Result Date) is the date of the forecast review of the publication
<TITLES> <TITLE Lang="en">Amendment 1 - International Electrotechnical Vocabulary - Part 617: Organization/Market of electricity</TITLE> <TITLE Lang="fr">Amendement 1 - Vocabulaire Electrotechnique International - Partie 617: Organisation/Marché de l'électricité</TITLE> </TITLES>	English title of the publication French title of the publication, if bilingual or French only 
<ABSTRACTS> <ABSTRACT Lang="en">Applies to automatic electrical temperature sensing controls for use in, on, or in association with equipment for household and similar use, that may use electricity or another source of energy.</ABSTRACT> <ABSTRACT Lang="fr">S'applique aux dispositifs de commande électrique automatiques thermosensibles pour usage dans, sur, ou en association avec des appareils à usage domestique et analogue, fonctionnant à l'électricité ou avec une autre source d'énergie.</ABSTRACT> </ABSTRACTS>	English abstract of the publication French abstract of the publication, if bilingual or French only 
<PAGES>11</PAGES>	Page number of the publication
<PRICECODE>F</PRICECODE>	Price code calculated according to page number and language, as per IEC pricing policy which is referenced in the Price Code XML Data Feed
<COMMITTEES> <COMMITTEE> <ID>1231</ID> <LABEL>TC 1</LABEL> </COMMITTEE> </COMMITTEES>	Committee linked to the publication ID : project primary key (i.e. electronic ID) which is referenced in the Committee XML Data Feed LABEL : Label of the committee 
<ICSCODES> <ICS> <CODE>01.040.29</CODE> <DESCRIPTION>Electrical engineering (Vocabularies)</DESCRIPTION> </ICS> <ICS> <CODE>01.040.27</CODE> <DESCRIPTION>Energy and heat transfer engineering (Vocabularies)</DESCRIPTION> </ICS> <ICS> <CODE></CODE> <DESCRIPTION></DESCRIPTION> </ICS> </ICSCODES>	International Classification for Standards codes and their descriptions Only the first one is mandatory 
<LASTMODIFICATIONDATE>	The date when metadata has been modified for the last time. Different

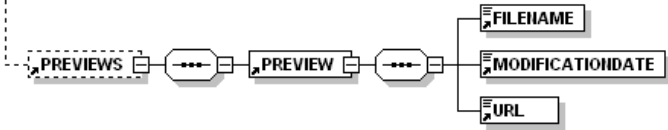
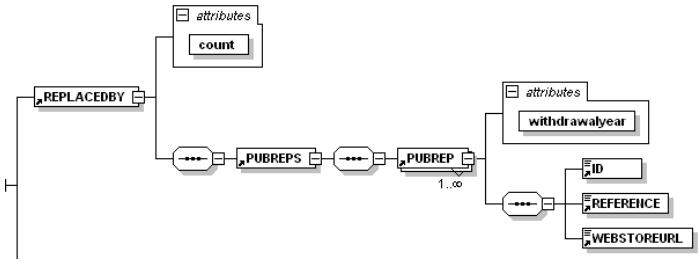
<p>2011-10-18 00:00:00 &lt;/LASTMODIFICATIONDATE&gt;</p>	<p>from the publishing date if metadata has been updated since creation</p>
<p>&lt;ISPREVIEW&gt;NO&lt;/ISPREVIEW&gt;</p>	<p>YES if the publication has a preview NO if the publication has not a preview</p>
<p>&lt;PREVIEWS&gt; &lt;PREVIEW&gt; &lt;FILENAME&gt;info_iec60050-702{ed1.0}b.img.pdf&lt;/FILENAME&gt; &lt;MODIFICATIONDATE&gt;2004-05-03 15:22:35&lt;/MODIFICATIONDATE&gt; &lt;URL&gt;ftp://preview.iec.ch/preview/info_iec60050-702{ed1.0}b.img.pdf&lt;/URL&gt; &lt;/PREVIEW&gt; &lt;/PREVIEWS&gt;</p>	<p>Preview of the publication FILENAME : File name of the preview URL : Link to access to the preview though FTP</p> 
<p>&lt;REPLACEDBY count="1"&gt; &lt;PUBREPS&gt; &lt;PUBREP withdrawalyear="1991"&gt; &lt;ID&gt;213&lt;/ID&gt; &lt;REFERENCE&gt;IEC 61089-1991&lt;/REFERENCE&gt; &lt;LANGUAGE&gt;EN-FR&lt;/REFERENCE&gt; &lt;WEBSTOREURL&gt;http://webstore.iec.ch/webstore/webstore.nsf/SW/P-IEC 61089 Ed. 1.0?OpenDocument&lt;/WEBSTOREURL&gt; &lt;/PUBREP&gt; &lt;/PUBREPS&gt; &lt;/REPLACEDBY&gt;</p>	<p>List of publication which replace the current publication ID : publication primary key (i.e. electronic ID) LANGUAGE : Publication language version WEBSTOREURL : Direct link to IEC Webstore REFERENCE : document reference is a concatenation of tags HEAD, TR, NUMBER, PART, SECTION, AMD</p> 
<p>&lt;/PUB&gt; &lt;/PUBS&gt;</p>	

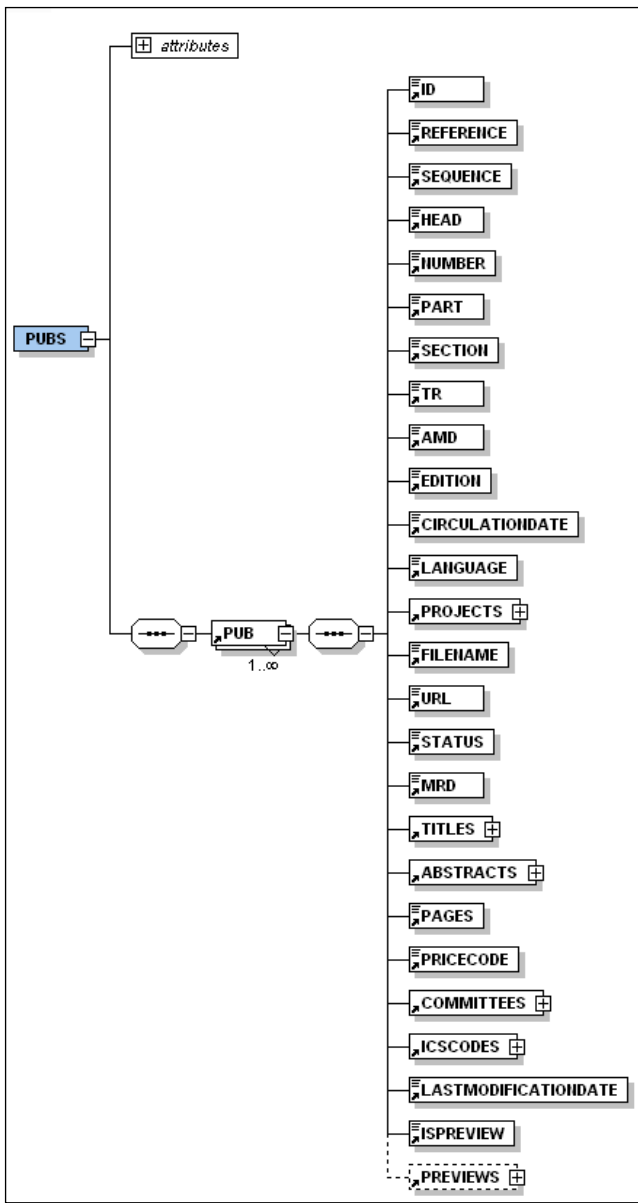

## 2 XML Projects

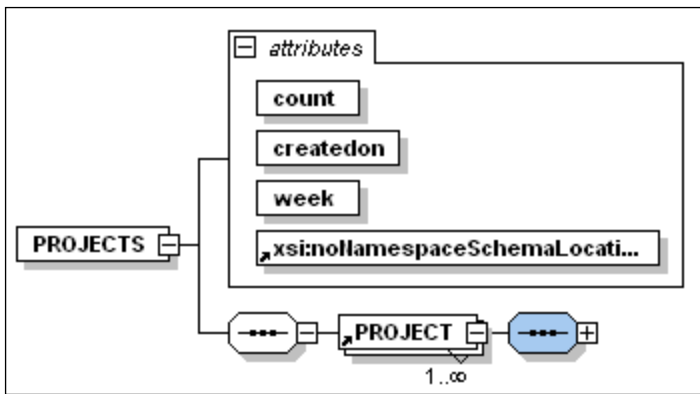

```
<?xml version = "1.0" encoding = "UTF-8"?>
```

```
<PROJECTS xmlns:xsi="http://www.w3.org/2001/XMLSchema-instance"
xsi:noNamespaceSchemaLocation="http://www.iec.ch/xsd/schemaprojects.xsd" createdon="2011-10-22 11:05:01" count="19536"
week="42">
```

- The XML format is **UTF 8**.
- Every line is indicated by XML TAG **PROJECT**.
- Date format is YYYY-MM-DD or YYYY-MM-DD hh:mm:ss (ex: 2004-04-05 00:00:00 or 2011-10-10)

xsi:noNamespaceSchemaLocation : URL Link to the XML Schema  
 count : Number of projects in the XML (Number of tags PROJECT)  
 createdon : Date when the XML has been generated  
 week : Current week when the XML has been generated

<PROJECT>	Tag for one Project
<ID>12875</ID>	Project primary key (i.e. electronic ID)
<REFERENCE>IEC 60068-1 Ed. 7.0</REFERENCE>	Project reference is a concatenation of tags HEAD, TR, NUMBER, PART, SECTION, AMD
<SEQUENCE>AA60068000001000000000000</SEQUENCE>	Tag used for publication sort
<HEAD>IEC</HEAD>	Project header
<PUBNUMBER>60068</PUBNUMBER>	Project number (mandatory)
<PART>1</PART>	Part number (optional)
<SECTION></SECTION>	Section number (optional)
<AMD>1</AMD>	Amendment number
<FRAG></FRAG>	Fragment
<TR></TR>	Type of Project if other than International Standard. TR = technical report, TS = technical specification
<EDITION>7</EDITION>	Full edition number of the project. Digits before dot are for edition number, digits after dot and not equal to 0 are for consolidated versions (1.2 stands for e first edition consolidated with its two amendments)
<LANGUAGE>B</LANGUAGE>	Project language. B = bilingual English and French, E = English only, F = French only, T = trilingual (English, French, Russian and/or Spanish),
<PUBS count="1"> <PUB> <ID>45537</ID> <REFERENCE>IEC/TR 62728</REFERENCE> </PUB> </PUBS>	<p>Publications list linked to the current project                      PUBS attribute                      count : number of publication linked to the project                      ID : Publication primary key (i.e. electronic ID) which is referenced in the Publications XML Data Feed                      REFERENCE : Publication Reference</p>

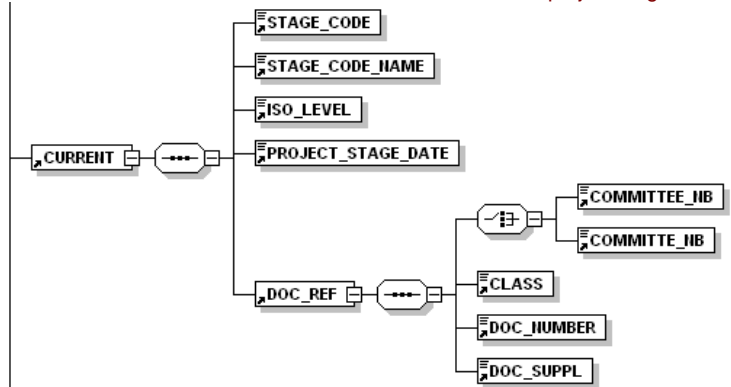
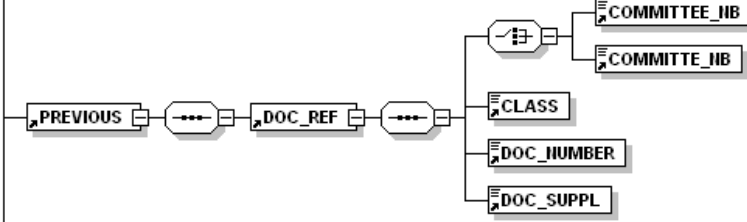
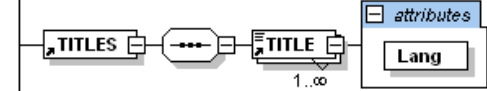

<pre> &lt;COMMITTEES&gt; &lt;COMMITTEE&gt; &lt;ID&gt;1308&lt;/ID&gt; &lt;LABEL&gt;104&lt;/LABEL&gt; &lt;/COMMITTEE&gt;         </pre>	<p>Committee linked to the project ID : project primary key (i.e. electronic ID) which is referenced in the Committee XML Data Feed LABEL : Label of the committee</p> 
<pre> &lt;PUBLICATIONDATE&gt;2011-09-09&lt;/PUBLICATIONDATE&gt;         </pre>	<p>Publication date of release linked to project</p>
<pre> &lt;ANWDATE&gt;&lt;/ANWDATE&gt;         </pre>	<p>Date of last ANW Project Stage Code</p>
<pre> &lt;AMWDATE&gt;2007-11-23&lt;/AMWDATE&gt;         </pre>	<p>Date of last AMW Project Stage Code</p>
<pre> &lt;CURRENT&gt;   &lt;STAGE_CODE&gt;ADIS&lt;/STAGE_CODE&gt;   &lt;STAGE_CODE_NAME&gt;Approved for FDIS   circulation&lt;/STAGE_CODE_NAME&gt;   &lt;ISO_LEVEL&gt;40.99&lt;/ISO_LEVEL&gt;   &lt;PROJECT_STAGE_DATE&gt;2011-09-   09&lt;/PROJECT_STAGE_DATE&gt;   &lt;DOC_REF&gt;     &lt;COMMITTEE_NB&gt;104&lt;/COMMITTEE_NB&gt;     &lt;CLASS&gt;&lt;/CLASS&gt;     &lt;DOC_NUMBER&gt;563&lt;/DOC_NUMBER&gt;     &lt;DOC_SUPPL&gt;&lt;/DOC_SUPPL&gt;   &lt;/DOC_REF&gt; &lt;/CURRENT&gt;         </pre>	<p>Information about current project stage STAGE_CODE : current stage code STAGE_CODE_NAME : description of current stage code ISO_LEVEL : ISO level of current stage PROJECT_STAGE_DATE DOC_REF : Information about the document link to current project stage</p> 
<pre> &lt;PREVIOUS&gt; &lt;DOC_REF&gt; &lt;COMMITTEE_NB&gt;104&lt;/COMMITTEE_NB&gt; &lt;CLASS&gt;&lt;/CLASS&gt; &lt;DOC_NUMBER&gt;517&lt;/DOC_NUMBER&gt; &lt;DOC_SUPPL&gt;&lt;/DOC_SUPPL&gt; &lt;/DOC_REF&gt; &lt;/PREVIOUS&gt;         </pre>	<p>Information about previous project document in previous stage DOC_REF : Information about the document link to current project stage</p> 
<pre> &lt;NEXT_STAGE_TARGET_DATE&gt;2011-11- 30&lt;/NEXT_STAGE_TARGET_DATE&gt;         </pre>	<p>Target date of next project stage</p>
<pre> &lt;TITLES&gt;   &lt;TITLE Lang="en"&gt;Environmental testing - Part 1: General   and guidance&lt;/TITLE&gt;   &lt;TITLE Lang="fr"&gt;Essais d'environnement - Partie 1:   Généralités et guide&lt;/TITLE&gt; &lt;/TITLES&gt;         </pre>	<p>English title of the project French title of the project, if bilingual or French only</p> 
<pre> &lt;REMARKS&gt;- Project restart from PWI - SMB/4114/DL (Tel   Aviv) approved for CCDV: 2009-12 &lt;/REMARKS&gt;         </pre>	<p>Remark on Project</p>
<pre> &lt;PARALLEL_VOTING&gt;yes&lt;/PARALLEL_VOTING&gt;         </pre>	<p>CENELEC parallel voting</p>
<pre> &lt;MODIFICATIONDATE&gt;2011-09-05&lt;/MODIFICATIONDATE&gt;         </pre>	<p>Last modification date of the current project</p>

</PROJECTS>

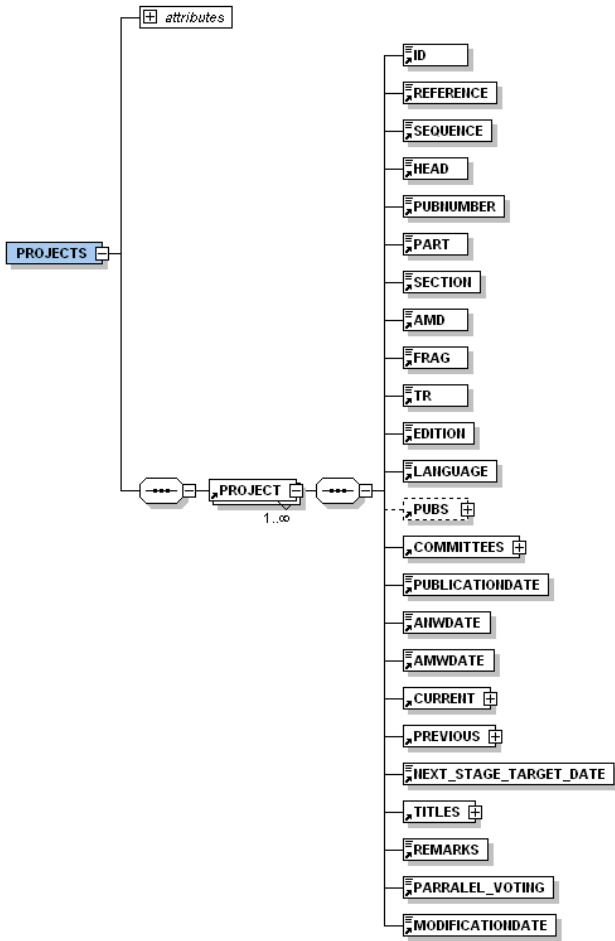

### 3. XML Working Documents (Newdocs & Revisable CDVs)

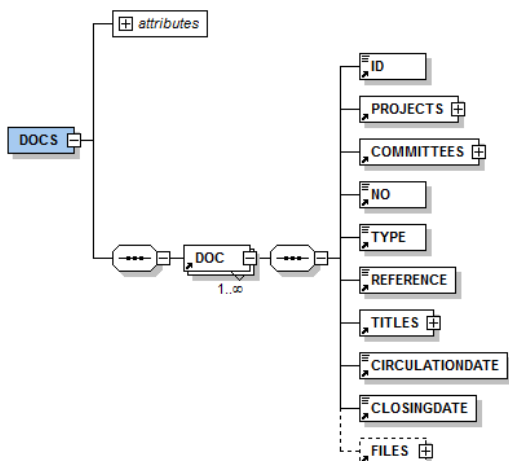

<?xml version="1.0" encoding="UTF-8"?>

<DOCS xmlns:xsi="http://www.w3.org/2001/XMLSchema-instance"  
xsi:noNamespaceSchemaLocation="http://www.iec.ch/xsd/schemadocuments.xsd" type="docsweekly42" createdon="2011-10-22  
11:35:01" count="183" week="42">

- The XML format is **UTF 8**.
- Every line is indicated by XML TAG **DOC**.
- Date format is YYYY-MM-DD or YYYY-MM-DD hh:mm:ss (ex: 2004-04-05 00:00:00 or 2011-10-10)
- Any TAGs are surrounded by **CDATA** in order to avoid special characters problems



xsi:noNamespaceSchemaLocation : URL Link to the XML Schema

type : docsweeklyXX for weekly XML current documents, XX is the week number of current year

count : Number of documents in the XML (Number of tags DOC)

createdon : Date when the XML has been generated

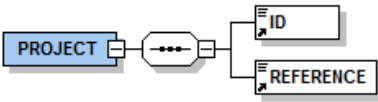
week : Current week when the XML has been generated (not used by Revisable CDVs)

<p>&lt;DOC&gt;</p>	<p>Tag for one document</p>										
<p>&lt;ID&gt;138240&lt;/ID&gt; &lt;PROJECTS&gt; &lt;PROJECT&gt; &lt;ID&gt;20237&lt;/ID&gt; &lt;REFERENCE&gt;IEC 60839-11-31 Ed. 1.0&lt;/REFERENCE&gt; &lt;/PROJECT&gt; &lt;/PROJECTS&gt;</p>	<p>Document primary key (i.e. electronic ID) The link on IEC Project. ID : project primary key (i.e electronic ID) which is referenced in the Projects XML Data Feeds REFERENCE : IEC Project reference</p> 										
<p>&lt;COMMITTEES&gt; &lt;COMMITTEE&gt; &lt;ID&gt;1220&lt;/ID&gt; &lt;LABEL&gt;&lt;![CDATA[TC 33]]&gt;&lt;/LABEL&gt; &lt;/COMMITTEE&gt; &lt;/COMMITTEES&gt;</p>	<p>Committee linked to the document ID : committee primary key (i.e. electronic ID) which is referenced in the Committee XML Data Feed LABEL : Label of the committee linked to the document</p> 										
<p>&lt;NO&gt;491&lt;/NO&gt; &lt;TYPE&gt;RVC&lt;/TYPE&gt;</p>	<p>Document number Document type</p> <table border="1" data-bbox="774 1892 1484 2060"> <thead> <tr> <th>TYPE</th> <th>DESCRIPTION</th> </tr> </thead> <tbody> <tr> <td>AC</td> <td>Administrative Circular</td> </tr> <tr> <td>CC</td> <td>Compilation of Comments on CD</td> </tr> <tr> <td>CD</td> <td>Committee Draft for Comments</td> </tr> <tr> <td>CDV</td> <td>Committee Draft for Voting</td> </tr> </tbody> </table>	TYPE	DESCRIPTION	AC	Administrative Circular	CC	Compilation of Comments on CD	CD	Committee Draft for Comments	CDV	Committee Draft for Voting
TYPE	DESCRIPTION										
AC	Administrative Circular										
CC	Compilation of Comments on CD										
CD	Committee Draft for Comments										
CDV	Committee Draft for Voting										

	<p>CL Circular Letter</p> <p>DA Draft Agenda</p> <p>DC Document for Comments</p> <p>DIS Draft International Standards</p> <p>DL Decision List</p> <p>DP Draft Proposal</p> <p>DTR Draft Technical Report</p> <p>DTS Draft Technical Specification</p> <p>DV Draft for Voting (C/CA only)</p> <p>EDR Essential Differences in Requirements</p> <p>FDIS Final Draft International Standard</p> <p>FMV Four Months' Vote (IECQ CMC only)</p> <p>INF Document for Information</p> <p>ISH Interpretation Sheet</p> <p>MCR Maintenance Cycle Report</p> <p>MT Maintenance Team List</p> <p>MTG Meeting Document</p> <p>NCC National Committee Comment (C/CA only)</p> <p>NCP National Committee Proposal</p> <p>NP New Work Item Proposal</p> <p>PAS Publicly Available Specification</p> <p>PW Programm of Work</p> <p>Q Questionnaire</p> <p>QP Question of Principle (CA only)</p> <p>R Report</p> <p>RCA Report to Committee of Action</p> <p>RM Report on Meeting</p> <p>RQ Report on Questionnaire</p> <p>RR Review Report</p> <p>RV Report of Voting (C/CA only)</p> <p>RVC Report of Voting on CDV</p> <p>RVD Report of Voting on FDIS or PAS</p> <p>RVN Report of Voting on NWP</p> <p>RVP Rep. of Voting on draft provisional specification</p> <p>RVS Report of Voting on SR</p> <p>SBP Strategic Business Plan</p> <p>SPS Strategy Policy Statement</p> <p>SR Systematic Review</p> <p>WD Working Document (SB1 only)</p> <p>WG Working Group Membership List</p>
<REFERENCE><![CDATA[33/491/RVC]]></REFERENCE>	Document reference
<p>&lt;TITLES&gt;</p> <p>&lt;TITLE Lang="en"&gt;&lt;![CDATA[Result of voting on 33/471/CDV: IEC 60358-1 Ed. 1.0: Coupling capacitors and capacitor dividers: Part 1: Common Clauses]]&gt;&lt;/TITLE&gt;</p> <p>&lt;TITLE Lang="fr"&gt;&lt;![CDATA[]]&gt;&lt;/TITLE&gt;</p> <p>&lt;/TITLES&gt;</p>	<p>English title of the document</p> <p>French title of the document</p>
<CIRCULATIONDATE>2011-10-21</CIRCULATIONDATE>	Document date of release
<CLOSINGDATE></CLOSINGDATE>	Document closing date (for voting)
<p>&lt;FILES&gt;</p> <p>&lt;FILEURL sizeinkb="179.50" filename="342e.doc" lang="en" type="doc"&gt;&lt;![CDATA[http://www.iec.ch/cgi-bin/restricted/getfile.pl/110_342e_RVC.doc?dir=110&amp;format=doc&amp;type=RVC&amp;file=342e.doc]]&gt;&lt;/FILEURL&gt;</p> <p>&lt;FILEURL sizeinkb="210.86" filename="342e.pdf" lang="en" type="pdf"&gt;&lt;![CDATA[http://www.iec.ch/cgi-bin/restricted/getfile.pl/110_342e_RVC.pdf?dir=110&amp;format=pdf&amp;type=RVC&amp;file=342e.pdf]]&gt;&lt;/FILEURL&gt;</p> <p>&lt;/FILES&gt;</p>	<p>Document files</p> <p>FILEURL Attributes</p> <p>lang : language of the document</p> <p>type : extension type of the document</p> <p>filename : document file name</p> <p>sizeinkb : document file size in kilo byte</p> <p>FILEURL : Authenticated URL access to the document file</p>

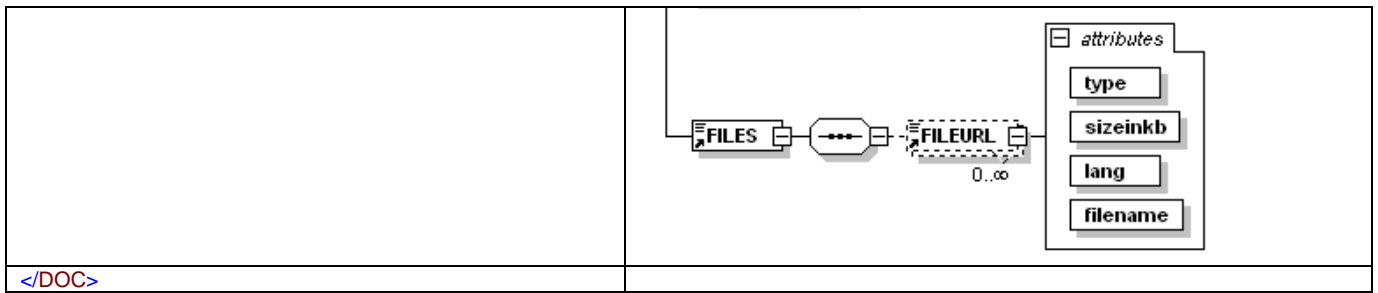

</DOC>

</DOCS>

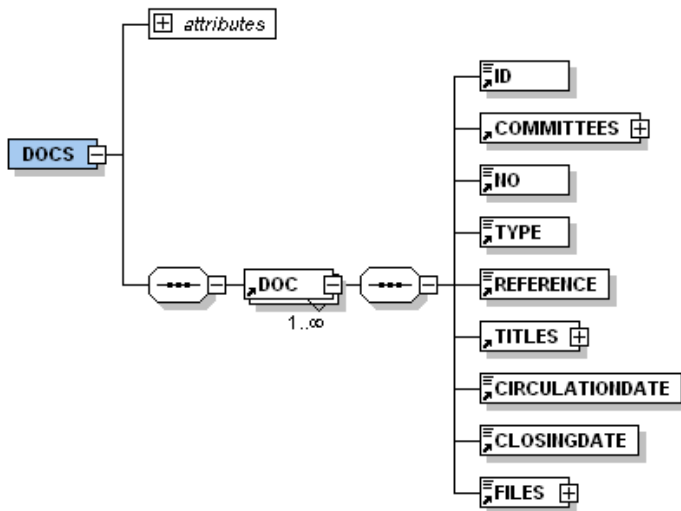

## 4. XML IEC Technical Committees

```
<ORGS xmlns:xsi="http://www.w3.org/2001/XMLSchema-instance"
xsi:noNamespaceSchemaLocation="http://www.iec.ch/xsd/schemaiectcsc.xsd" type="IEC TC/SC" createdon="2011-10-22 11:05:01"
count="208">
```

- The XML format is **UTF 8**.
- Every line is indicated by XML TAG **ORG**.
- Date format is YYYY-MM-DD or YYYY-MM-DD hh:mm:ss (ex: 2004-04-05 00:00:00 or 2011-10-10)
- Any TAGs are surrounded by **CDATA** in order to avoid special characters problems

<ORG num="1">	Tag for one committee
<SEQUENCE>1TC 00001.00</SEQUENCE>	Sequence of the committee linked to sort committees
<NAME_EN>Terminology</NAME_EN>	English title of the committee
<ORG_ID>1231</ORG_ID>	Committee primary key (i.e. electronic ID) Linked to XML Publications and XML Projects
<ORG_TYPE_ID>4</ORG_TYPE_ID>	Committee type 4 : Technical Committee (TC) 5 : Sub-Committee (SC) 6 : Technical Area (TA) 25 : ISO/IEC Joint Project Committee (JPC) 95 : ISO/IEC Joint Technical Committee 1 (JTC 1) 96 : ISO/IEC Joint Technical Sub-Committee 1 (JTC 1/SC)
<CODE>1</CODE>	Committee code (ex : TC 4, Code = 4 / SC 3B, code = 3B)
<LABEL>TC 1</LABEL>	Committee label (ex : TC 3/SC 3B)
<SECRETARIAT>Spain</SECRETARIAT>	National Committee Secretariat of the committee
<TCCHAIRMAN>Mr Carlo Angelo Borghi</TCCHAIRMAN>	Chairman of the committee
<TCSECRETARY>Mr Miguel A. Aranda</TCSECRETARY>	Secretary of the committee
<SCOPEEN><![CDATA[To sanction the terms and definitions used in the different electrotechnical fields and to determine the equivalence of the terms used in the different languages.  As a consequence, to prepare an International Electrotechnical Vocabulary aiming at the standardization and coordination of the1 terms relating to electrical sciences and techniques for use in the technical language and literature, in teaching, in technical specifications and in commercial exchanges, and at giving their equivalents in the different languages.]]></SCOPEEN>	English scope of the committee
<SHORTLABEL>TC 1</SHORTLABEL>	Short Label of the committee (ex : TC 3/SC 3B, short label = SC 3B)
<COUNTPUBSORT>110</COUNTPUBSORT>	Number of current publications linked to the committee
<COUNTPROJSORT>8</COUNTPROJSORT>	Number of current project files linked to the committee
</ORG>	

```
</ORGS>
```

## 5. XML IEC Working Groups

This feeder integrates every type of IEC Working Groups of Technical Committees (TC), Subcommittees (SC), Project Committee (PT), Joint Project Committee (JPT), and ISO/IEC JTC 1/SC 25:

Working Group (WG), Joint Working Group (JWG), Maintenance Team (MT), Join Maintenance Team (JMT), Project Team (PT), Joint Project Team (JPT), Validation Team (VT), Joint Task Force (JTF), ad-Hoc Group (AHG), Joint ad-Hoc Group (JAHG), Advisory Groups (AG).

```
<ORGS xmlns:xsi="http://www.w3.org/2001/XMLSchema-instance"
xsi:noNamespaceSchemaLocation="http://www.iec.ch/xsd/schemaiecwgws.xsd" type="IEC Working Group" createdon="2011-10-22
11:35:01" count="1372">
```

- The XML format is **UTF 8**.
- Every line is indicated by XML TAG **ORG**.
- Date format is YYYY-MM-DD or YYYY-MM-DD hh:mm:ss (ex: 2004-04-05 00:00:00 or 2011-10-10)
- Any TAGs are surrounded by **CDATA** in order to avoid special characters problems

<ORG>	Tag for one Working Group
<SEQUENCE><![CDATA[1TC 000020.00 WG 000016.00]]></SEQUENCE>	Sequence of the Working Group linked to sort committees and Working Group
<COMMITTEE> <ID>1214</ID> <LABEL><![CDATA[TC 20]]></LABEL> <SHORTLABEL><![CDATA[TC 20]]></SHORTLABEL> </COMMITTEE>	Data about the parent committee of the Working Group : - Committee primary key (i.e. electronic ID) - Linked to XML TC/SC - Committee Label - Committee Short Label
<TITLES> <TITLE Lang="en"><![CDATA[High voltage cables (1kV and above), their accessories and cable systems]]></TITLE> <TITLE Lang="fr"><![CDATA[]]></TITLE> </TITLES>	English and French title of the Working Group
<TYPE_ID>7</TYPE_ID>	Working Group type 7 : Working Group 8 : Project Team 9 : Maintenance Team 10 : Joint Working Group 11 : Advisory Group 12 : ad-Hoc Group 14 : Joint Task Force 15 : Validation Team 19 : Joint Maintenance Team 20 : Joint Project Team 26 : Joint ad-Hoc Group
<STATUS_ID>1</STATUS_ID>	Working Group Status 1 : Active 3 : Disbanded
<CODE><![CDATA[16]]></CODE>	Working Group code (ex : TC 20/WG 16, Code = 16)
<LABEL><![CDATA[TC 20/WG 16]]></LABEL>	Working Group label (ex : TC 20/WG 16)
<SHORTLABEL><![CDATA[WG 16]]></SHORTLABEL>	Working Group Short Label (ex : WG 16)
<CREATIONDATE>2008-07-25</CREATIONDATE>	Creation date of the Working Group
<SCOPES> <SCOPE Lang="en"><![CDATA[To prepare and maintain standards for cables of 1 kV and above, the accessories and cable systems.]]></SCOPE> <SCOPE Lang="fr"><![CDATA[Préparer et maintenir les normes des câbles de tension 1 kV et au-dessus, de leurs accessoires et des systèmes de câbles.]]></SCOPE> </SCOPES>	Task/Scope of the Working Group

<p>&lt;MEMBERS count="44"&gt; &lt;PERSON role="Member" dependency="JP"&gt;Mr Masaru Watanabe&lt;/PERSON&gt; &lt;PERSON role="Member" dependency="IT"&gt;Mr Sergio Meregalli&lt;/PERSON&gt; &lt;PERSON role="Member" dependency="FI"&gt;Mr Mika Mutru&lt;/PERSON&gt; &lt;PERSON role="Convenor" dependency="IT"&gt;Mr Ernesto Zaccone&lt;/PERSON&gt; &lt;PERSON role="Member" dependency="FR"&gt;Mr Pierre Mirebeau&lt;/PERSON&gt; &lt;PERSON role="Member" dependency="CA"&gt;Mr Lauri J. Hiivala&lt;/PERSON&gt; (,,,,) &lt;/MEMBERS&gt;</p>	<p>The Working Group member with his dependency and role (Convenor, Member, or Project Leader)</p>
<p>&lt;/ORG&gt;</p>	

</ORGS>



## 6. XML IEC Price Codes

```
<?xml version = '1.0' encoding = 'UTF-8'?>
```

- The XML format is **UTF 8**.
- Every line is indicated by XML TAG **PRICECODE**.

```
<PRICECODES>
```

<PRICECODE num="1">	Tag for one price code
<HEAD>IEC</HEAD>	Price code header
<GRP>A</GRP>	Price code Group
<PRICE>14</PRICE>	Price code value
<MINPG>1</MINPG>	Min value of pages for this price code
<MAXPG>2</MAXPG>	Max value of pages for this price code
</PRICECODE>	

```
</PRICECODES>
```

## 7. XML International Classification for Standards (ICS Codes)

```
<?xml version = '1.0' encoding = 'UTF-8'?>
```

- The XML format is **UTF 8**.
- Every line is indicated by XML TAG **ISCCODE**.
- Date format is YYYY-MM-DD or YYYY-MM-DD hh:mm:ss (ex: 2004-04-05 00:00:00 or 2011-10-10)

```
<ICSCODES>
```

<ICSCODE num="1">	Tag for one ICS code
<ICS>01</ICS>	ICS code
<TXTE>GENERALITIES. TERMINOLOGY. STANDARDIZATION. DOCUMENTATION</TXTE>	English ICS code description
<TXTF>GÉNÉRALITÉS. TERMINOLOGIE. NORMALISATION. DOCUMENTATION</TXTF>	French ICS code description
<DATSAI>2009-07-30</DATSAI>	IEC ICS code creation date
</ICSCODE>	

```
</ICSCODES>
```

## 8. FTP

The XML metadata for Publications, Corrigenda and Project Files are also available on file format on IEC FTP Server. These files are generated **every Saturday 12am**.

Host : **ftp://preview.iec.ch/preview/XML**  
Anonymous access





















Every week, 10 files are uploaded (the end file is the generation date):

**Export-List-Publications-2011-12-10.xml** : All the publications  
**Export-List-P-Publications-2011-12-10.xml** : All the replaced/withdrawn publications  
**Export-List-Corrigenda-2011-12-10.xml** : All the Corrigenda  
**Export-List-P-Corrigenda-2011-12-10.xml** : All the replaced/withdrawn Corrigenda  
**Export-List-ProjectFiles-2011-12-10.xml** : All the Project Files

**Export-List-Publications-week44-2011-12-10.xml** : All the new publications of week 44  
**Export-List-P-Publications-week44-2011-12-10.xml** : All the new replaced/withdrawn publications of week 44  
**Export-List-Corrigenda-week44-2011-12-10.xml** : All the new Corrigenda of week 44  
**Export-List-P-Corrigenda-week44-2011-12-10.xml** : All the new replaced/withdrawn Corrigenda of week 44  
**Export-List-ProjectFiles-week44-2011-12-10.xml** : All the new Project Files of week 44.

The week number changes obviously during the year.

We have three weeks of history so 30 files permanently on the server.

 export-list-corrigenda-2012-03-03.xml	645'278	XML Docu...	2012-03-03 06:59:00
 export-list-corrigenda-2012-03-10.xml	651'936	XML Docu...	2012-03-12 18:16:00
 export-list-corrigenda-2012-03-17.xml	650'258	XML Docu...	2012-03-21 09:24:00
 export-list-corrigenda-week11-2012-03-17.xml	265	XML Docu...	2012-03-21 09:24:00
 export-list-p-corrigenda-2012-03-03.xml	749'588	XML Docu...	2012-03-03 07:00:00
 export-list-p-corrigenda-2012-03-10.xml	751'127	XML Docu...	2012-03-12 18:17:00
 export-list-p-corrigenda-2012-03-17.xml	725'005	XML Docu...	2012-03-21 09:24:00
 export-list-p-corrigenda-week11-2012-03-17.xml	268	XML Docu...	2012-03-21 09:24:00
 export-list-p-publications-2012-03-03.xml	14'652'593	XML Docu...	2012-03-03 06:52:00
 export-list-p-publications-2012-03-10.xml	14'659'678	XML Docu...	2012-03-12 17:48:00
 export-list-p-publications-2012-03-17.xml	14'999'154	XML Docu...	2012-03-21 09:24:00
 export-list-p-publications-week11-2012-03-17.xml	264	XML Docu...	2012-03-21 09:24:00
 export-list-projectfiles-2012-03-03.xml	29'277'631	XML Docu...	2012-03-03 07:24:00
 export-list-projectfiles-2012-03-10.xml	29'309'426	XML Docu...	2012-03-10 07:24:00
 export-list-projectfiles-2012-03-17.xml	29'335'405	XML Docu...	2012-03-21 09:24:00
 export-list-projectfiles-week11-2012-03-17.xml	219'248	XML Docu...	2012-03-21 09:24:00
 export-list-publications-2012-03-03.xml	18'731'355	XML Docu...	2012-03-03 06:59:00
 export-list-publications-2012-03-10.xml	18'732'893	XML Docu...	2012-03-12 18:15:00
 export-list-publications-2012-03-17.xml	18'855'845	XML Docu...	2012-03-21 09:24:00
 export-list-publications-week11-2012-03-17.xml	144'388	XML Docu...	2012-03-21 09:24:00

One file is all the time available :

**iec\_stage\_codes.xml** : List of IEC Stage Codes on XML format

A directory **\XMLSchema** contains the entire XML schema used for XML generation:

schemapublications.xsd : Schema for replaced/withdrawn Publications  
 schemapublications.xsd : Schema for Publications  
 schemacorrigenda.xsd : Schema for Corrigenda  
 schemapcorrigena.xsd : Schema for replaced/withdrawn Corrigenda  
 schemadocuments.xsd : Schema for Working Documents  
 schemaprojects.xsd : Schema for Project Files

## 9. Reports

IEC Data Feeds gives two reports on the generation of XML files on IEC FTP server. These reports confirm that the Saturday process happened without problems.

It could be very useful if IEC Data Feeds is used by automatic process in order to be sure that the data are correctly generated.

Example of Publication report:

### IEC Data Feeds on 2012-03-20

IEC Data Feeds On-line Data are available [here](#)  
IEC Data Feeds XML files are available by FTP [here](#)

Steps	Date/Time
<b>Generate XML for Publications Active</b>	
WEEK : 11	2012-03-20 03:35:25
TABLE WEEKLY TEMPLATE : PUBSWEEKXML11	2012-03-20 03:35:25
TABLE TEMPLATE : PUBSXML	2012-03-20 03:35:25
FILE : Export-List-Publications-2012-03-17.xml	2012-03-20 03:35:25
WEEK FILE : Export-List-Publications-week11-2012-03-17.xml	2012-03-20 03:35:25
TYPE : pubs	2012-03-20 03:35:25
PUBLICATON FULL DATA GENERATED SUCCESSFULLY	2012-03-20 04:01:43
DIRECTORY : pubsweekly11	2012-03-20 04:01:43
TYPE : pubsweekly11	2012-03-20 04:01:43
FILE UPLOADED : pubsweekly11/WeeklyPublication-11-46190-2012-03-17.xml	2012-03-20 04:01:43
FILE UPLOADED : pubsweekly11/WeeklyPublication-11-46191-2012-03-17.xml	2012-03-20 04:01:43
FILE UPLOADED : pubsweekly11/WeeklyPublication-11-46179-2012-03-17.xml	2012-03-20 04:01:43
FILE UPLOADED : pubsweekly11/WeeklyPublication-11-46192-2012-03-17.xml	2012-03-20 04:01:43
FILE UPLOADED : pubsweekly11/WeeklyPublication-11-46180-2012-03-17.xml	2012-03-20 04:01:44
FILE UPLOADED : pubsweekly11/WeeklyPublication-11-46181-2012-03-17.xml	2012-03-20 04:01:44
FILE UPLOADED : pubsweekly11/WeeklyPublication-11-46193-2012-03-17.xml	2012-03-20 04:01:44
FILE UPLOADED : pubsweekly11/WeeklyPublication-11-46194-2012-03-17.xml	2012-03-20 04:01:44
FILE UPLOADED : pubsweekly11/WeeklyPublication-11-46182-2012-03-17.xml	2012-03-20 04:01:44
FILE UPLOADED : pubsweekly11/WeeklyPublication-11-46183-2012-03-17.xml	2012-03-20 04:01:44
FILE UPLOADED : pubsweekly11/WeeklyPublication-11-46195-2012-03-17.xml	2012-03-20 04:01:44
FILE UPLOADED : pubsweekly11/WeeklyPublication-11-46196-2012-03-17.xml	2012-03-20 04:01:44
FILE UPLOADED : pubsweekly11/WeeklyPublication-11-46184-2012-03-17.xml	2012-03-20 04:01:44
FILE UPLOADED : pubsweekly11/WeeklyPublication-11-46197-2012-03-17.xml	2012-03-20 04:01:44
FILE UPLOADED : pubsweekly11/WeeklyPublication-11-46198-2012-03-17.xml	2012-03-20 04:01:45
FILE UPLOADED : pubsweekly11/WeeklyPublication-11-46185-2012-03-17.xml	2012-03-20 04:01:45
FILE UPLOADED : pubsweekly11/WeeklyPublication-11-46199-2012-03-17.xml	2012-03-20 04:01:45
FILE UPLOADED : pubsweekly11/WeeklyPublication-11-46186-2012-03-17.xml	2012-03-20 04:01:45
FILE UPLOADED : pubsweekly11/WeeklyPublication-11-46200-2012-03-17.xml	2012-03-20 04:01:45
FILE UPLOADED : pubsweekly11/WeeklyPublication-11-46187-2012-03-17.xml	2012-03-20 04:01:45
FILE UPLOADED : pubsweekly11/WeeklyPublication-11-46201-2012-03-17.xml	2012-03-20 04:01:45
FILE UPLOADED : pubsweekly11/WeeklyPublication-11-46188-2012-03-17.xml	2012-03-20 04:01:45
FILE UPLOADED : pubsweekly11/WeeklyPublication-11-46202-2012-03-17.xml	2012-03-20 04:01:45
FILE UPLOADED : pubsweekly11/WeeklyPublication-11-46189-2012-03-17.xml	2012-03-20 04:01:45
FILE UPLOADED : pubsweekly11/WeeklyPublication-11-46164-2012-03-17.xml	2012-03-20 04:01:45
FILE UPLOADED : pubsweekly11/WeeklyPublication-11-46165-2012-03-17.xml	2012-03-20 04:01:46

FILE UPLOADED : pubsweekly11/WeeklyPublication-11-46166-2012-03-17.xml	2012-03-20 04:01:46
FILE UPLOADED : pubsweekly11/WeeklyPublication-11-46167-2012-03-17.xml	2012-03-20 04:01:46
FILE UPLOADED : pubsweekly11/WeeklyPublication-11-46168-2012-03-17.xml	2012-03-20 04:01:46
FILE UPLOADED : pubsweekly11/WeeklyPublication-11-46169-2012-03-17.xml	2012-03-20 04:01:46
FILE UPLOADED : pubsweekly11/WeeklyPublication-11-46217-2012-03-17.xml	2012-03-20 04:01:46
FILE UPLOADED : pubsweekly11/WeeklyPublication-11-46218-2012-03-17.xml	2012-03-20 04:01:46
FILE UPLOADED : pubsweekly11/WeeklyPublication-11-46220-2012-03-17.xml	2012-03-20 04:01:46
FILE UPLOADED : pubsweekly11/WeeklyPublication-11-46221-2012-03-17.xml	2012-03-20 04:01:46
FILE UPLOADED : pubsweekly11/WeeklyPublication-11-46222-2012-03-17.xml	2012-03-20 04:01:46
FILE UPLOADED : pubsweekly11/WeeklyPublication-11-46203-2012-03-17.xml	2012-03-20 04:01:47
FILE UPLOADED : pubsweekly11/WeeklyPublication-11-46204-2012-03-17.xml	2012-03-20 04:01:47
FILE UPLOADED : pubsweekly11/WeeklyPublication-11-46205-2012-03-17.xml	2012-03-20 04:01:47
FILE UPLOADED : pubsweekly11/WeeklyPublication-11-46206-2012-03-17.xml	2012-03-20 04:01:47
FILE UPLOADED : pubsweekly11/WeeklyPublication-11-46207-2012-03-17.xml	2012-03-20 04:01:47
FILE UPLOADED : pubsweekly11/WeeklyPublication-11-46208-2012-03-17.xml	2012-03-20 04:01:47
FILE UPLOADED : pubsweekly11/WeeklyPublication-11-46209-2012-03-17.xml	2012-03-20 04:01:47
FILE UPLOADED : pubsweekly11/WeeklyPublication-11-46210-2012-03-17.xml	2012-03-20 04:01:47
FILE UPLOADED : pubsweekly11/WeeklyPublication-11-46216-2012-03-17.xml	2012-03-20 04:01:47
44 FILE(S) SUCESSFULLY UPLOADED IN \pubsweekly11	2012-03-20 04:01:47
PUBLICATON WEEKLY DATA GENERATED SUCCESSFULLY	2012-03-20 04:01:47
<b>Generate XML for Publications Replaced/Withdrawn</b>	
WEEK : 11	2012-03-20 04:01:48
TABLE WEEKLY TEMPLATE : PPUBSWEEKXML11	2012-03-20 04:01:48
TABLE TEMPLATE : PPUBSXML	2012-03-20 04:01:48
FILE : Export-List-P-Publications-2012-03-17.xml	2012-03-20 04:01:48
WEEK FILE : Export-List-P-Publications-week11-2012-03-17.xml	2012-03-20 04:01:48
TYPE : rwpubs	2012-03-20 04:01:48
PUBLICATON FULL DATA GENERATED SUCCESSFULLY	2012-03-20 04:30:24
DIRECTORY : ppubsweekly11	2012-03-20 04:30:24
TYPE : rwpubsweekly11	2012-03-20 04:30:24
0 FILE(S) SUCESSFULLY UPLOADED IN \ppubsweekly11	2012-03-20 04:30:24
PUBLICATON WEEKLY DATA GENERATED SUCCESSFULLY	2012-03-20 04:30:24
<b>Generate XML for Corrigenda Active</b>	
WEEK : 11	2012-03-20 04:30:25
TABLE WEEKLY TEMPLATE : CORRWEEKXML11	2012-03-20 04:30:25
TABLE TEMPLATE : CORRXML	2012-03-20 04:30:25
FILE : Export-List-Corrigenda-2012-03-17.xml	2012-03-20 04:30:25
WEEK FILE : Export-List-Corrigenda-week11-2012-03-17.xml	2012-03-20 04:30:25
TYPE : corrigenda	2012-03-20 04:30:25
PUBLICATON FULL DATA GENERATED SUCCESSFULLY	2012-03-20 04:31:05
DIRECTORY : corrigendaweekly11	2012-03-20 04:31:05
TYPE : corrigendaweekly11	2012-03-20 04:31:05
0 FILE(S) SUCESSFULLY UPLOADED IN \corrigendaweekly11	2012-03-20 04:31:05
PUBLICATON WEEKLY DATA GENERATED SUCCESSFULLY	2012-03-20 04:31:05
<b>Generate XML for Corrigenda Replaced/Withdrawn</b>	
WEEK : 11	2012-03-20 04:31:05
TABLE WEEKLY TEMPLATE : PCORRWEEKXML11	2012-03-20 04:31:05

TABLE TEMPLATE : PCORRXML	2012-03-20 04:31:05
FILE : Export-List-P-Corrigenda-2012-03-17.xml	2012-03-20 04:31:05
WEEK FILE : Export-List-P-Corrigenda-week11-2012-03-17.xml	2012-03-20 04:31:05
TYPE : rwcorigenda	2012-03-20 04:31:05
PUBLICATON FULL DATA GENERATED SUCCESSFULLY	2012-03-20 04:31:54
DIRECTORY : pcorrigendaweekly11	2012-03-20 04:31:54
TYPE : rwcorigendaweekly11	2012-03-20 04:31:54
0 FILE(S) SUCESSFULLY UPLOADED IN \pcorrigendaweekly11	2012-03-20 04:31:55
PUBLICATON WEEKLY DATA GENERATED SUCCESSFULLY	2012-03-20 04:31:55

Example of Project Files report:

## IEC Data Feeds on 2012-03-21

IEC Data Feeds On-line Data are available [here](#)  
IEC Data Feeds XML files are available by FTP [here](#)

Action	Date
<b>Generate XML for Project Files</b>	
WEEK : 11	2012-03-21 09:41:29
TABLE WEEKLY TEMPLATE : PROJECTSWEEKXML11	2012-03-21 09:41:29
TABLE TEMPLATE : PROJECTSXML	2012-03-21 09:41:29
GLOBAL FILE : Export-List-ProjectFiles-2012-03-17.xml	2012-03-21 09:41:29
WEEKLY FILE : Export-List-ProjectFiles-Week11-2012-03-17.xml	2012-03-21 09:41:29
PROJECT FILES FULL DATA GENERATED SUCCESSFULLY	2012-03-21 11:22:34
DIRECTORY : projectswweekly11	2012-03-21 11:22:34
FILE UPLOADED : projectswweekly11/WeeklyProjectFile-11-20141-2012-03-17.xml	2012-03-21 11:22:34
FILE UPLOADED : projectswweekly11/WeeklyProjectFile-11-20143-2012-03-17.xml	2012-03-21 11:22:34
FILE UPLOADED : projectswweekly11/WeeklyProjectFile-11-20144-2012-03-17.xml	2012-03-21 11:22:34
FILE UPLOADED : projectswweekly11/WeeklyProjectFile-11-19692-2012-03-17.xml	2012-03-21 11:22:34
FILE UPLOADED : projectswweekly11/WeeklyProjectFile-11-20145-2012-03-17.xml	2012-03-21 11:22:34
FILE UPLOADED : projectswweekly11/WeeklyProjectFile-11-20146-2012-03-17.xml	2012-03-21 11:22:34
FILE UPLOADED : projectswweekly11/WeeklyProjectFile-11-17910-2012-03-17.xml	2012-03-21 11:22:35
FILE UPLOADED : projectswweekly11/WeeklyProjectFile-11-15942-2012-03-17.xml	2012-03-21 11:22:35
FILE UPLOADED : projectswweekly11/WeeklyProjectFile-11-18778-2012-03-17.xml	2012-03-21 11:22:35
FILE UPLOADED : projectswweekly11/WeeklyProjectFile-11-18779-2012-03-17.xml	2012-03-21 11:22:35
FILE UPLOADED : projectswweekly11/WeeklyProjectFile-11-18780-2012-03-17.xml	2012-03-21 11:22:35
FILE UPLOADED : projectswweekly11/WeeklyProjectFile-11-18781-2012-03-17.xml	2012-03-21 11:22:35
FILE UPLOADED : projectswweekly11/WeeklyProjectFile-11-18782-2012-03-17.xml	2012-03-21 11:22:35
FILE UPLOADED : projectswweekly11/WeeklyProjectFile-11-18953-2012-03-17.xml	2012-03-21 11:22:35
FILE UPLOADED : projectswweekly11/WeeklyProjectFile-11-19212-2012-03-17.xml	2012-03-21 11:22:35
FILE UPLOADED : projectswweekly11/WeeklyProjectFile-11-19735-2012-03-17.xml	2012-03-21 11:22:35
FILE UPLOADED : projectswweekly11/WeeklyProjectFile-11-18907-2012-03-17.xml	2012-03-21 11:22:36
FILE UPLOADED : projectswweekly11/WeeklyProjectFile-11-19031-2012-03-17.xml	2012-03-21 11:22:36
FILE UPLOADED : projectswweekly11/WeeklyProjectFile-11-19286-2012-03-17.xml	2012-03-21 11:22:36
FILE UPLOADED : projectswweekly11/WeeklyProjectFile-11-10914-2012-03-17.xml	2012-03-21 11:22:36
FILE UPLOADED : projectswweekly11/WeeklyProjectFile-11-12327-2012-03-17.xml	2012-03-21 11:22:36
FILE UPLOADED : projectswweekly11/WeeklyProjectFile-11-19389-2012-03-17.xml	2012-03-21 11:22:36
FILE UPLOADED : projectswweekly11/WeeklyProjectFile-11-13476-2012-03-17.xml	2012-03-21 11:22:36





FILE UPLOADED : projectsweekly11/WeeklyProjectFile-11-18129-2012-03-17.xml	2012-03-21 11:22:46
FILE UPLOADED : projectsweekly11/WeeklyProjectFile-11-18130-2012-03-17.xml	2012-03-21 11:22:46
FILE UPLOADED : projectsweekly11/WeeklyProjectFile-11-19670-2012-03-17.xml	2012-03-21 11:22:46
FILE UPLOADED : projectsweekly11/WeeklyProjectFile-11-19797-2012-03-17.xml	2012-03-21 11:22:46
FILE UPLOADED : projectsweekly11/WeeklyProjectFile-11-19808-2012-03-17.xml	2012-03-21 11:22:46
FILE UPLOADED : projectsweekly11/WeeklyProjectFile-11-18351-2012-03-17.xml	2012-03-21 11:22:46
FILE UPLOADED : projectsweekly11/WeeklyProjectFile-11-19326-2012-03-17.xml	2012-03-21 11:22:46
FILE UPLOADED : projectsweekly11/WeeklyProjectFile-11-18301-2012-03-17.xml	2012-03-21 11:22:46
FILE UPLOADED : projectsweekly11/WeeklyProjectFile-11-19266-2012-03-17.xml	2012-03-21 11:22:46
FILE UPLOADED : projectsweekly11/WeeklyProjectFile-11-19839-2012-03-17.xml	2012-03-21 11:22:47
FILE UPLOADED : projectsweekly11/WeeklyProjectFile-11-19334-2012-03-17.xml	2012-03-21 11:22:47
FILE UPLOADED : projectsweekly11/WeeklyProjectFile-11-17931-2012-03-17.xml	2012-03-21 11:22:47
FILE UPLOADED : projectsweekly11/WeeklyProjectFile-11-17062-2012-03-17.xml	2012-03-21 11:22:47
FILE UPLOADED : projectsweekly11/WeeklyProjectFile-11-20142-2012-03-17.xml	2012-03-21 11:22:47
FILE UPLOADED : projectsweekly11/WeeklyProjectFile-11-18879-2012-03-17.xml	2012-03-21 11:22:47
FILE UPLOADED : projectsweekly11/WeeklyProjectFile-11-17048-2012-03-17.xml	2012-03-21 11:22:47
FILE UPLOADED : projectsweekly11/WeeklyProjectFile-11-19791-2012-03-17.xml	2012-03-21 11:22:47
FILE UPLOADED : projectsweekly11/WeeklyProjectFile-11-20138-2012-03-17.xml	2012-03-21 11:22:47
FILE UPLOADED : projectsweekly11/WeeklyProjectFile-11-20147-2012-03-17.xml	2012-03-21 11:22:47
FILE UPLOADED : projectsweekly11/WeeklyProjectFile-11-19701-2012-03-17.xml	2012-03-21 11:22:48
FILE UPLOADED : projectsweekly11/WeeklyProjectFile-11-20098-2012-03-17.xml	2012-03-21 11:22:48
FILE UPLOADED : projectsweekly11/WeeklyProjectFile-11-19125-2012-03-17.xml	2012-03-21 11:22:48
FILE UPLOADED : projectsweekly11/WeeklyProjectFile-11-20091-2012-03-17.xml	2012-03-21 11:22:48
FILE UPLOADED : projectsweekly11/WeeklyProjectFile-11-17731-2012-03-17.xml	2012-03-21 11:22:48
141 FILE(S) UPLOADED IN \projectsweekly11	2012-03-21 11:22:48
PROJECT FILES WEEKLY DATA GENERATED SUCCESSFULLY	2012-03-21 11:22:48